



# TYPHOON INTAKE SYSTEMS

NOT LEGAL FOR SALE OR USE ON ANY POLLUTION CONTROLLED MOTOR VEHICLE IN CALIFORNIA OR STATES ADOPTING CALIFORNIA EMISSION PROCEDURES.  
See knfilters.com for CARB status on each part for a specific vehicle

## INSTALLATION INSTRUCTIONS

**69-5309TS**  
**HYUNDAI / KIA**  
**2011-14 Sonata / Optima**  
**L4-2.0L Turbo**

**TOOLS NEEDED:**

- Ratchet
- Extension
- 10mm socket
- 5/16" socket
- 4mm Allen wrench
- Flat blade screw driver
- Pliers

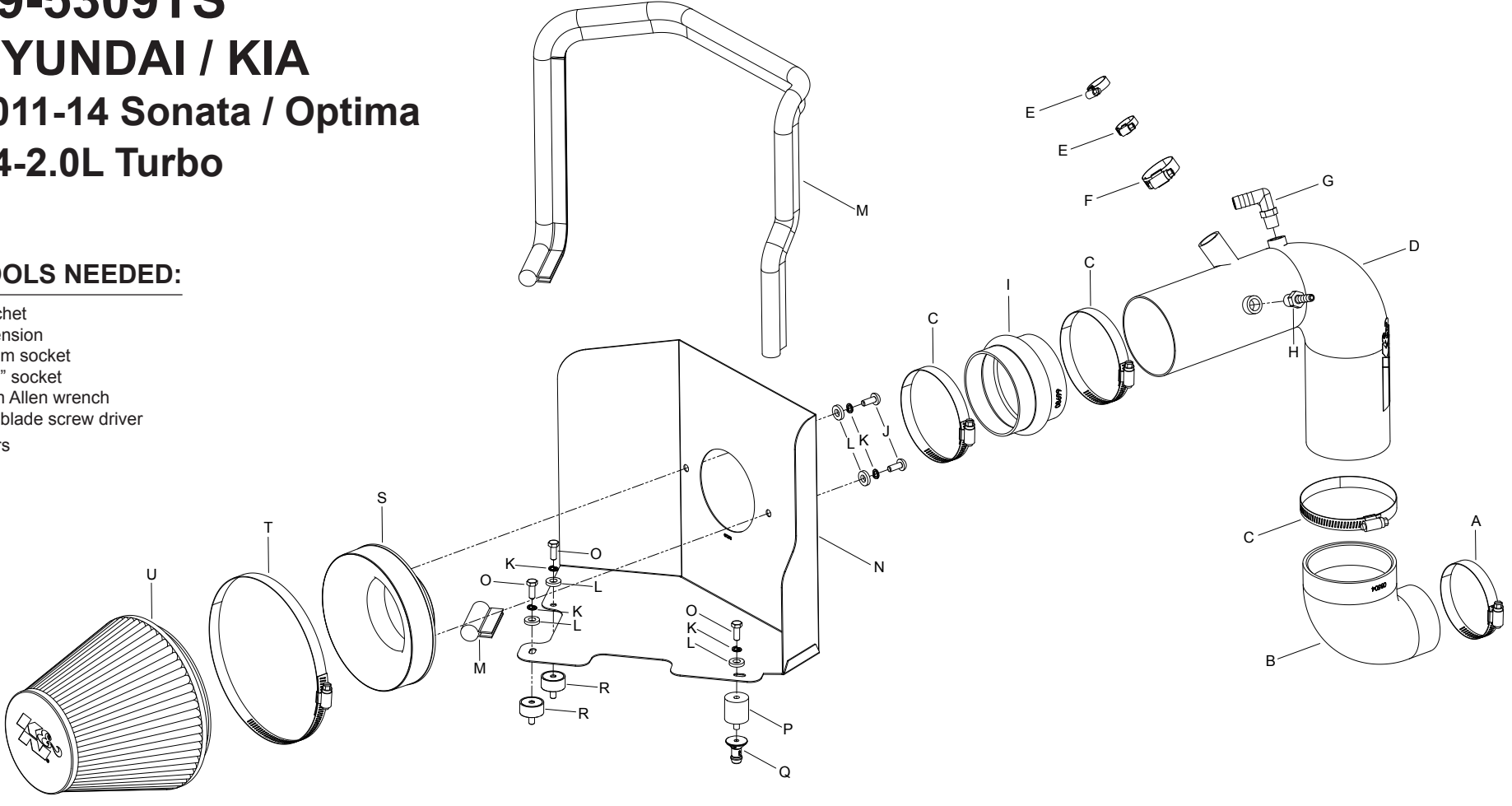

**PARTS LIST:**

Description	Qty.	Part #	Description	Qty.	Part #	Description	Qty.	Part #
A Hose Clamp #44 Stainless	1	08560	H Vent; STRT, 3/8" Hose, 1/4"NPT, Plas	1	08047	O Bolt; 6MM-1.00 X 16MM, SS	3	07812
B Hose; 3.5"ID to 2.5"ID, 90DE, Reinroced	1	08504	I Hose; 3-1/2" ID X 2-1/2"L Hump	1	08699	P Stud; Rubber Mount, M6 X 1, 1" T, M/F	1	02033
C Hose Clamp #56	3	08620	J Bolt; M6 X 1.00 X 16MM, Buttonhead	2	07730	Q Mount, Plastic Airbox	1	8-186-1
D Intake Tube	1	27577TS	K Washer, M6 Split Lock Zinc	5	1-3025	R Stud; Rubber MNT, M/F, 1/2"L X 1"W	2	070228
E Hose Clamp #6 MINI	2	08407	L Washer; 1/4"ID X 5/8"OD -SAE	5	08275	S Adapter; Universal, 6" Filter 3.5" Coupler	1	21512-1
F Hose Clamp #16	1	08413	M Edge Trim (44")	1	102486	T Hose Clamp #104	1	08697
G Vent; 90DEG, 1/2"Hose, 1/4"NPT, Black	1	08110FK	N Heat Shield	1	07393	U Air Filter	1	RF-1048

**NOTE: FAILURE TO FOLLOW INSTALLATION INSTRUCTIONS AND NOT USING THE PROVIDED HARDWARE MAY DAMAGE THE INTAKE TUBE, THROTTLE BODY AND ENGINE.**

**TO START:**

1. Turn off the ignition and disconnect the negative battery cable.  
**NOTE: Disconnecting the negative battery cable erases pre-programmed electronic memories. Write down all memory settings before disconnecting the negative battery cable. Some radios will require an anti-theft code to be entered after the battery is reconnected. The anti-theft code is typically supplied with your owner's manual. In the event your vehicles' anti-theft code cannot be recovered, contact an authorized dealership to obtain your vehicles anti-theft code.**

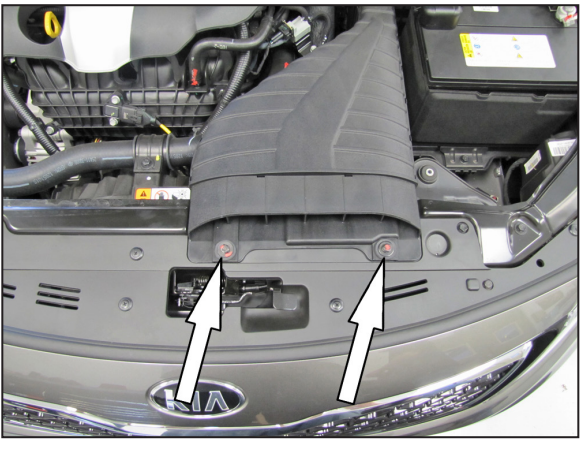

2. Remove the two bolts that secure the fresh air intake scoop to the core support and then remove the fresh air intake scoop from the vehicle.

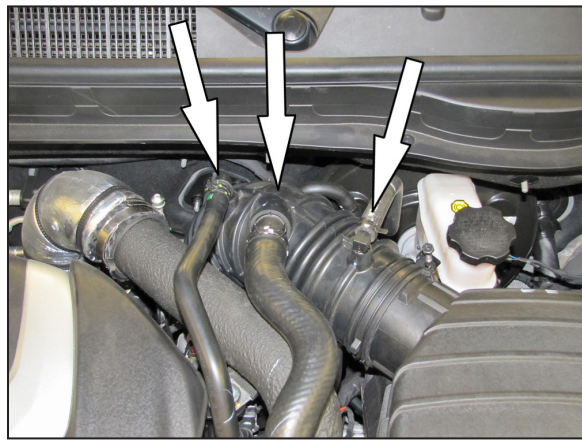

3. Loosen the spring clamps and then disconnect the Blow off valve hose, EVAP hose and Crank case vent hose from the intake tube.  
**NOTE: the spring clamps will not be reused.**

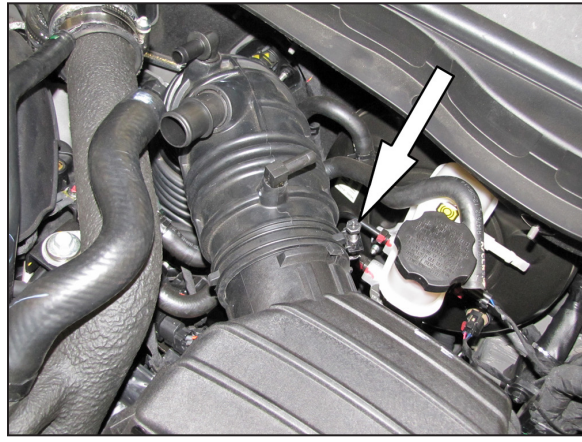

4. Loosen the hose clamp securing the intake hose to the air box.

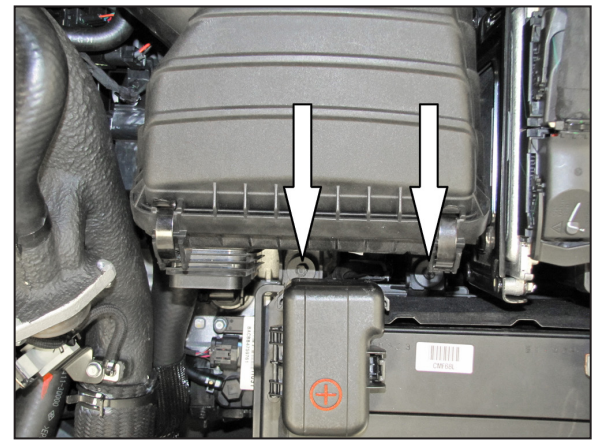

5. Remove the two bolts securing the air box to the mounting bracket. Then remove the air box from the vehicle.  
**NOTE: K&N Engineering, Inc., recommends that customers do not discard factory air intake.**



6. Loosen the hose clamp securing the intake tube to the turbo inlet and then remove the intake hose from the vehicle.

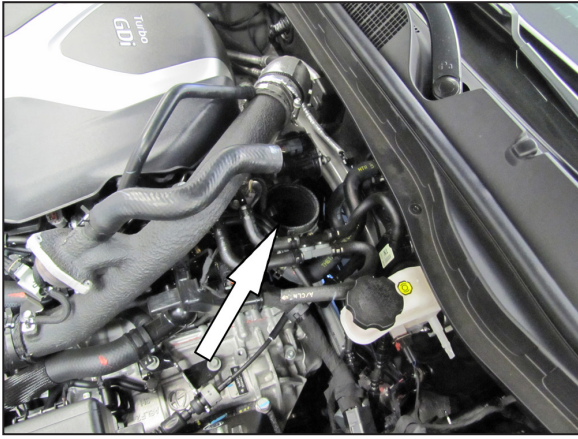

7. Install the provided 90° elbow hose (08504) onto the turbo inlet and secure with the provided hose clamp.  
**NOTE: Do not completely tighten at this time.**

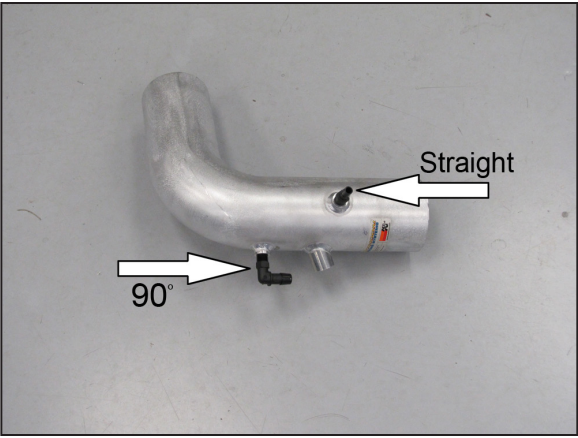

8. Install the provided 90° and straight vent fittings into the K&N® intake tube as shown.



9. Set the K&N® intake tube into position in the silicone hose; do not completely tighten the hose clamp at this time.

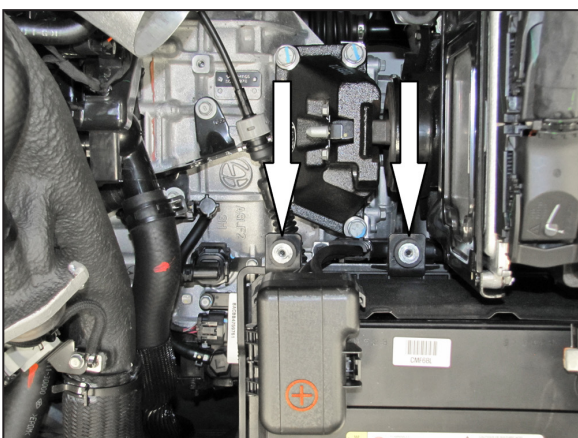

10. Install the two 1/2" high rubber mounted studs provided into the air box mount bolt locations.



11. Install the provided 1" high rubber mounted stud into the heat shield mounting stud.

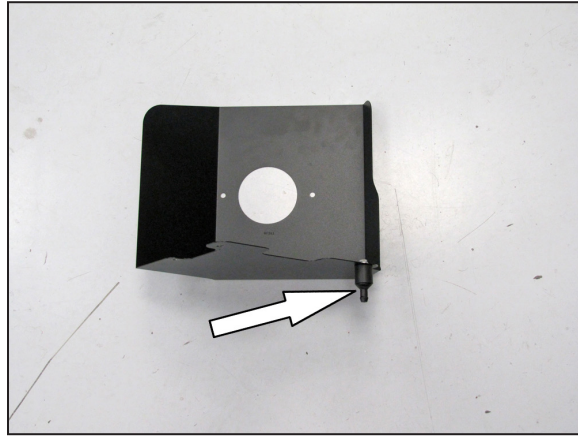

12. Install the heat shield mounting stud onto the heat shield as shown using the provided hardware.

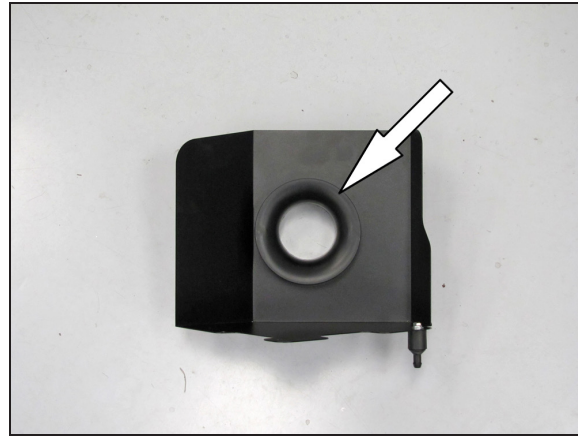

13. Install the air filter adapter into the heat shield and secure with the provided hardware.

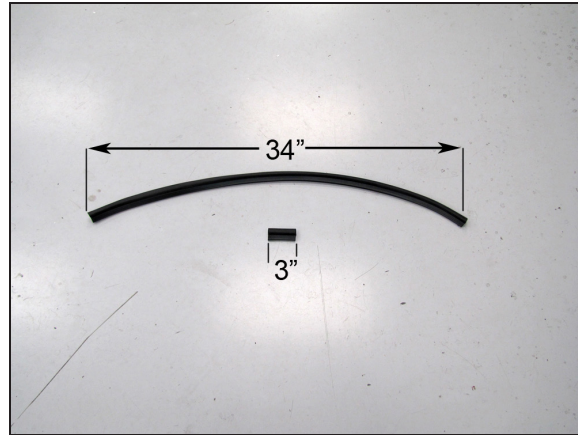

14. Cut the provided edge trim into two sections as shown. One section is to be 39" long and one section will be 3" long.

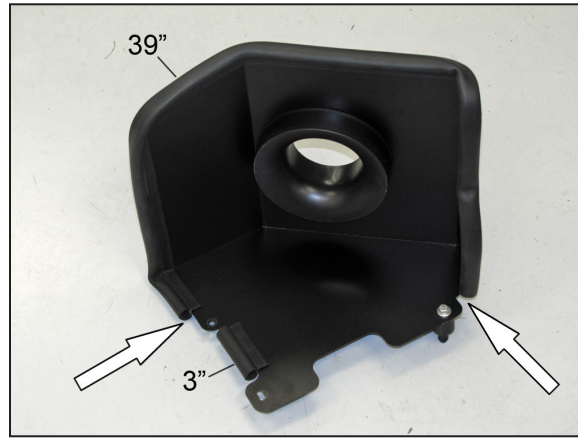

15. Install the edge trim onto the heat shield as shown



16. Slide the silicone hose (08699) onto the intake tube all the way on. Do not tighten at this time.



17. Set the heat shield into position on the rubber mounted studs and secure with the provided hardware.



18. Align the intake tube with the filter adapter and slide the silicone hose onto the adapter. Tighten all of the hose clamps for the upper and lower silicone hoses securing the intake tube.

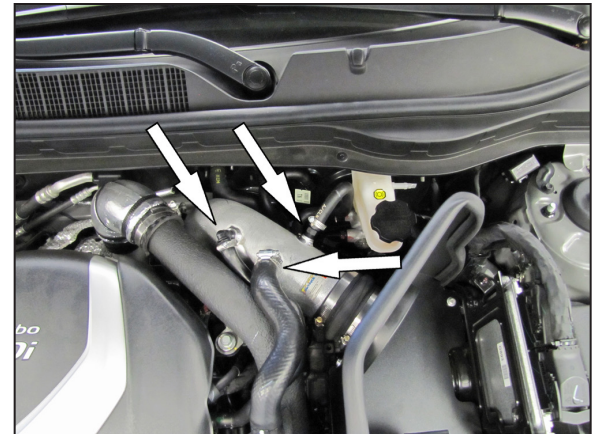

19. Connect the Blow of valve hose, EVAP hose and crank case vent hose to the intake tube and secure with the provided hose clamps.



20. Install the K&N® air filter and secure with the provided hose clamp.  
**NOTE: Drycharger® air filter wrap; part # RF-1048DK is available to purchase separately. To learn more about Drycharger® filter wraps or look up color availability please visit <http://www.knfilters.com>®.**

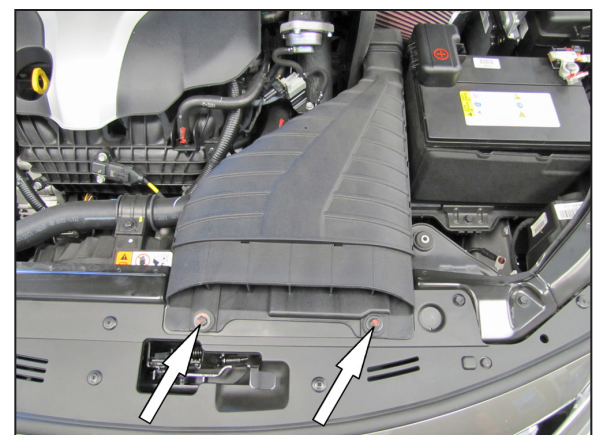

21. Reinstall the fresh air intake scoop and secure with the factory hardware.



22. Reconnect the vehicle's negative battery cable. Double check to make sure everything is tight and properly positioned before starting the vehicle.

23. It will be necessary for all K&N® high flow intake systems to be checked periodically for realignment, clearance and tightening of all connections. Failure to follow the above instructions or proper maintenance may void warranty.

**ROAD TESTING:**

1. Start the engine with the transmission in neutral or park, and the parking brake engaged. Listen for air leaks or odd noises. For air leaks secure hoses and connections. For odd noises, find cause and repair before proceeding. This kit will function identically to the factory system except for being louder and much more responsive.

2. Test drive the vehicle. Listen for odd noises or rattles and fix as necessary.

3. If road test is fine, you can now enjoy the added power and performance from your kit.

4. K&N Engineering, Inc., requires cleaning the intake system's air filter element every 100,000 miles. When used in dusty or off-road environments, our filters will require cleaning more often. We recommend that you visually inspect your filter once every 25,000 miles to determine if the screen is still visible. When the screen is no longer visible some place on the filter element, it is time to clean it. To clean and re-oil, purchase our filter Recharger® service kit, part number 99-5050 or 99-5000 and follow the easy instructions.

**NOT LEGAL FOR SALE OR USE ON ANY POLLUTION CONTROLLED MOTOR VEHICLE IN CALIFORNIA OR STATES ADOPTING CALIFORNIA EMISSION PROCEDURES.**

See [knfilters.com](http://knfilters.com) for CARB status on each part for a specific vehicle